



User Guide

SI-Encoder

Part Number: 0478-0127-01
Issue: 1



www.controltechniques.com

General information

The manufacturer accepts no liability for any consequences resulting from inappropriate, negligent or incorrect installation or adjustment of the optional operating parameters of the equipment or from mismatching the variable speed drive with the motor.

The contents of this guide are believed to be correct at the time of printing. In the interests of a commitment to a policy of continuous development and improvement, the manufacturer reserves the right to change the specification of the product or its performance, or the contents of the guide, without notice.

All rights reserved. No parts of this guide may be reproduced or transmitted in any form or by any means, electrical or mechanical including photocopying, recording or by an information storage or retrieval system, without permission in writing from the publisher.

Firmware version

This product is supplied with the latest firmware version. If this product is to be connected to an existing system or machine, all firmware versions should be verified to confirm the same functionality as products of the same model already present. This may also apply to products returned from a Control Techniques Service Centre or Repair Centre. If there is any doubt please contact the supplier of the product.

The firmware version can be checked by looking at Pr **xx.002**.

Environmental statement

Control Techniques is committed to minimising the environmental impacts of its manufacturing operations and of its products throughout their life cycle. To this end, we operate an Environmental Management System (EMS) which is certified to the International Standard ISO 14001. Further information on the EMS, our Environmental Policy and other relevant information is available on request, or can be found at www.greendrives.com.

The electronic variable-speed drives manufactured by Control Techniques have the potential to save energy and (through increased machine/process efficiency) reduce raw material consumption and scrap throughout their long working lifetime. In typical applications, these positive environmental effects far outweigh the negative impacts of product manufacture and end-of-life disposal.

Nevertheless, when the products eventually reach the end of their useful life, they must not be discarded but should instead be recycled by a specialist recycler of electronic equipment. Recyclers will find the products easy to dismantle into their major component parts for efficient recycling. Many parts snap together and can be separated without the use of tools, while other parts are secured with conventional fasteners. Virtually all parts of the product are suitable for recycling.

Product packaging is of good quality and can be re-used. Large products are packed in wooden crates, while smaller products come in strong cardboard cartons which themselves have a high recycled fibre content. If not re-used, these containers can be recycled. Polythene, used on the protective film and bags for wrapping product, can be recycled in the same way. Control Techniques' packaging strategy prefers easily-recyclable materials of low environmental impact, and regular reviews identify opportunities for improvement.

When preparing to recycle or dispose of any product or packaging, please observe local legislation and best practice.

REACH legislation

EC Regulation 1907/2006 on the Registration, Evaluation, Authorisation and restriction of Chemicals (REACH) requires the supplier of an article to inform the recipient if it contains more than a specified proportion of any substance which is considered by the European Chemicals Agency (ECHA) to be a Substance of Very High Concern (SVHC) and is therefore listed by them as a candidate for compulsory authorisation.

For current information on how this requirement applies in relation to specific Control Techniques products, please approach your usual contact in the first instance. Control Techniques position statement can be viewed at:

<http://www.controltechniques.com/REACH>

Copyright © April 2014 Control Techniques Ltd

Issue Number: 1

Firmware: 01.00.00.30 onwards

For patent and intellectual property related information please go to: www.ctpatents.info

Contents

1	How to use this guide	4
1.1	Intended personnel	4
1.2	Information	4
2	Safety information	5
2.1	Warnings, Cautions and Notes	5
2.2	Electrical safety - general warning	5
2.3	System design and safety of personnel	5
2.4	Environmental limits	6
2.5	Access	6
2.6	Compliance with regulations	6
2.7	Adjusting parameters	6
2.8	Stored charge	6
3	Introduction	7
3.1	Features	7
3.2	Option module identification	7
3.3	Set-up parameters	7
3.4	Compatible encoder types	8
4	Installing the option module	9
4.1	General installation	9
5	Electrical installation	10
5.1	Terminal descriptions	10
5.2	Wiring, Shield connections	10
6	Getting started	15
6.1	Installation	15
6.2	SI-Encoder set-up	16
6.3	Termination resistors	16
7	Parameters	17
7.1	Menus	17
7.2	Single line descriptions	18
7.3	Parameter descriptions	19
8	Diagnostics	32
8.1	Overview	32
9	Terminal data	34
9.1	Encoder inputs	34

1 How to use this guide

1.1 Intended personnel

This guide is intended for personnel who have the necessary training and experience in system design, installation, commissioning and maintenance.

1.2 Information

This guide contains information covering the identification of the option module, terminal layout for installation, fitting of the option module to the drive, parameter details and diagnosis information. Additional to the aforementioned are the specifications of the option module.

2 Safety information

2.1 Warnings, Cautions and Notes



WARNING

A Warning contains information which is essential for avoiding a safety hazard.



CAUTION

A Caution contains information which is necessary for avoiding a risk of damage to the product or other equipment.

NOTE

A Note contains information which helps to ensure correct operation of the product.

2.2 Electrical safety - general warning

The voltages used in the drive can cause severe electrical shock and/or burns, and could be lethal. Extreme care is necessary at all times when working with or adjacent to the drive.

Specific warnings are given at the relevant places in this User Guide.

2.3 System design and safety of personnel

The drive is intended as a component for professional incorporation into complete equipment or a system. If installed incorrectly, the drive may present a safety hazard. The drive uses high voltages and currents, carries a high level of stored electrical energy, and is used to control equipment which can cause injury. Close attention is required to the electrical installation and the system design to avoid hazards either in normal operation or in the event of equipment malfunction. System design, installation, Commissioning/start-up and maintenance must be carried out by personnel who have the necessary training and experience. They must read this safety information and this User Guide carefully.

The STOP and SAFE TORQUE Off functions of the drive do not isolate dangerous voltages from the output of the drive or from any external option unit. The supply must be disconnected by an approved electrical isolation device before gaining access to the electrical connections.

With the sole exception of the SAFE TORQUE Off function, none of the drive functions must be used to ensure safety of personnel, i.e. they must not be used for safety-related functions.

Careful consideration must be given to the functions of the drive which might result in a hazard, either through their intended behavior or through incorrect operation due to a fault. In any application where a malfunction of the drive or its control system could lead to or allow damage, loss or injury, a risk analysis must be carried out, and where necessary, further measures taken to reduce the risk - for example, an over-speed protection device in case of failure of the speed control, or a fail-safe mechanical brake in case of loss of motor braking.

The system designer is responsible for ensuring that the complete system is safe and designed correctly according to the relevant safety standards.

2.4 Environmental limits

Instructions in the *Drive User Guide* regarding transport, storage, installation and use of the drive must be complied with, including the specified environmental limits. Drives must not be subjected to excessive physical force.

2.5 Access

Drive access must be restricted to authorized personnel only. Safety regulations which apply at the place of use must be complied with.

2.6 Compliance with regulations

The installer is responsible for complying with all relevant regulations, such as national wiring regulations, accident prevention regulations and electromagnetic compatibility (EMC) regulations. Particular attention must be given to the cross-sectional areas of conductors, the selection of fuses or other protection, and protective earth (ground) connections.

The *Drive User Guide* contains instructions for achieving compliance with specific EMC standards.

Within the European Union, all machinery in which this product is used must comply with the following directives:

- 2006/42/EC: Safety of machinery.
- 2004/108/EC: Electromagnetic Compatibility.

2.7 Adjusting parameters

Some parameters have a profound effect on the operation of the drive. They must not be altered without careful consideration of the impact on the controlled system.

Measures must be taken to prevent unwanted changes due to error or tampering.

2.8 Stored charge

The drive contains capacitors that remain charged to a potentially lethal voltage after the AC supply has been disconnected. If the drive has been energized, the AC supply must be isolated at least ten minutes before work may continue.

3 Introduction

3.1 Features

The SI-Encoder option module provides an interface for connecting an AB quadrature encoder to the drive, to be used as position and speed feedback for the drive. Typical uses for this option module would be to provide a speed feedback interface for motor control or to input speed a speed/position reference from a line speed encoder.

3.2 Option module identification

The SI-Encoder can be identified by:

1. The label located on the topside of the option module.
2. The color coding across the front of the option module: light brown.

Figure 3-1 SI-Encoder label

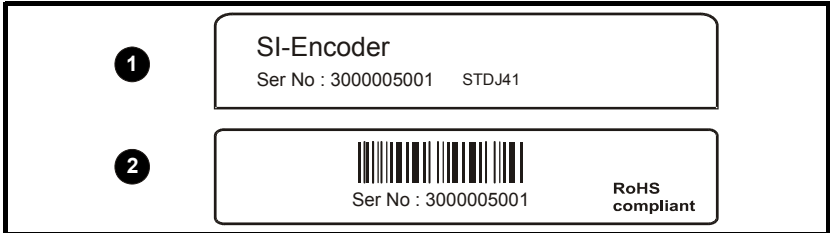

3.2.1 Date code format

The date code is split into two sections: a letter followed by a number.

The letter indicates the year, and the number indicates the week number (within the year) in which the option module was built.

The letters go in alphabetical order, starting with A in 1990 (B in 1991, C in 1992 etc.).

Example:

A date code of W35 would correspond to week 35 of year 2013.

3.3 Set-up parameters

All parameters associated with the SI-Encoder can be found in either menu 15, 16, or 17. Each of menus 15, 16, and 17 refer to one of the available slots into which the option module can be fitted. Slot 1 = Menu 15, Slot 2 = Menu 16, Slot 3 = Menu 17.

3.4 Compatible encoder types

The SI-Encoder module is compatible with incremental AB encoders without a marker pulse.

Incremental encoders AB without marker pulse

This type of encoder gives incremental position and its intended use is for motor control in RFC-A mode. It can also be used for motor control in RFC-S mode, although no communication signals are present, so a phasing autotune must be performed when the drive powers up initially or after an encoder trip.

Type	Encoder	Description
Incremental	AB	Quadrature incremental encoder. Without marker pulse.

Quadrature detection logic determines rotation from the phase relationship of the two channels.

Limitations			
Type	Encoder	Max Input Frequency	Max no. of Lines (LPR)
Incremental	AB	500 kHz*	65,536

*Max input frequency = LPR x rpm / 60

NOTE The maximum speed in rpm which an encoder connected to the SI-Encoder can reach can be calculated from :

$$\text{Max rpm} = (60 \times \text{Max input frequency}) / \text{Encoder LPR}$$

e.g. For a 4096 line encoder the maximum rpm would be:

$$(60 \times 500 \times 10^3) / 4096 = 7324 \text{ rpm}$$

Figure 3-2 Encoder feedback signals

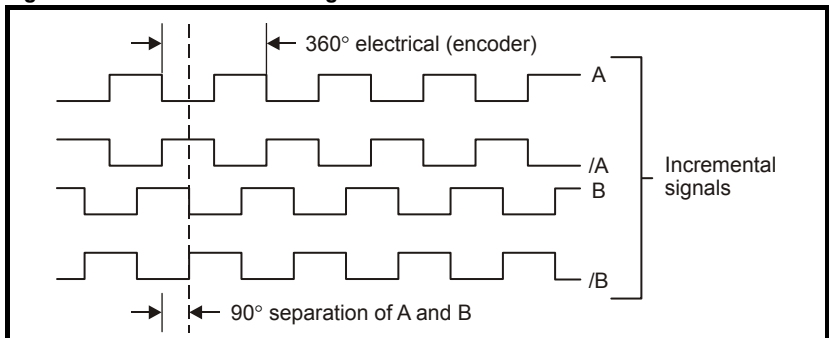

NOTE Only encoders with lines per revolution that are a power of 2 can be used with the SI-Encoder, e.g. 256, 512, 1024 etc.

3.4.1 Drive firmware compatibility

The SI-Encoder module is compatible with the Unidrive M600 to M810 range of drives. The recommended drive firmware version is V01.08.00.00 or later.

4 Installing the option module



WARNING

Before installing or removing an option module from any drive, ensure the AC supply has been disconnected for at least 10 minutes and refer to section 1 *Safety information* on page 4. If using a DC bus supply ensure this is fully discharged before working on any drive or option module.

4.1 General installation

Installation of an option module is illustrated in Figure 4-1.

Figure 4-1 Installing an option module

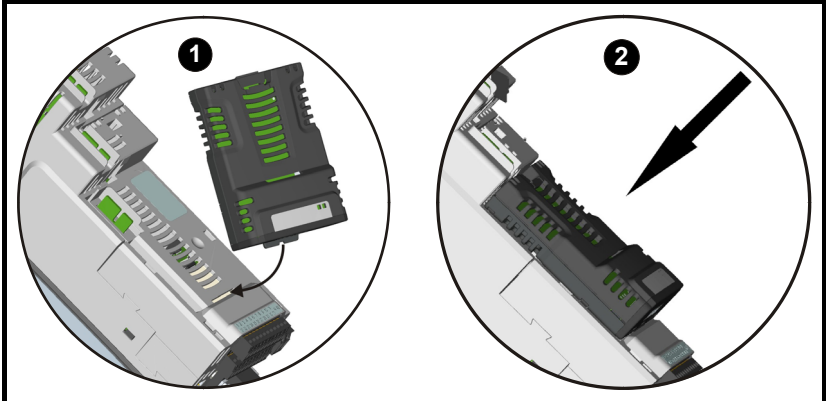

- Option module slots must be used in the following order: slot 3 (lower), slot 2 (middle) and slot 1 (upper).
- Orientate the option module above the drive as shown (1) in the first image above.
- Align and insert the option module tab into the slot and press down until the option module locks into place.

NOTE

Option modules can only be installed on drives that have the option module slot functionality as shown in Figure 4-1 above.

5 Electrical installation

5.1 Terminal descriptions

Figure 5-1 SI-Encoder terminals

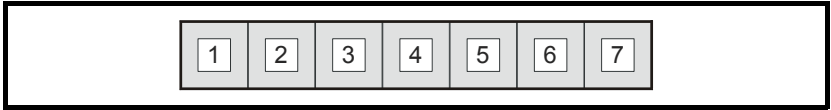

Table 5.1 SI-Encoder terminal descriptions

Terminal	Encoder inputs
	AB
1	A
2	A\
3	B
4	B\
5	+V
6	0V
7	0V

5.2 Wiring, Shield connections

Shielding considerations are important for PWM drive installations due to the high voltages and currents present in the output circuit with a very wide frequency spectrum, typically from 0 to 20 M Hz. Encoder inputs are liable to be disturbed if careful attention is not given to managing the cable shields.

Encoder mounting methods

There are three methods for mounting an encoder onto a motor:

1. Galvanic isolation between encoder and motor
2. Galvanic isolation between encoder circuit and encoder body
3. No Isolation

5.2.1 Encoder with galvanic isolation from motor

When galvanically isolated the encoder device is mounted to the motor with isolation fitted between the motor housing / shaft and encoder as shown in Figure 5-2 .

Figure 5-2 Galvanic Isolation

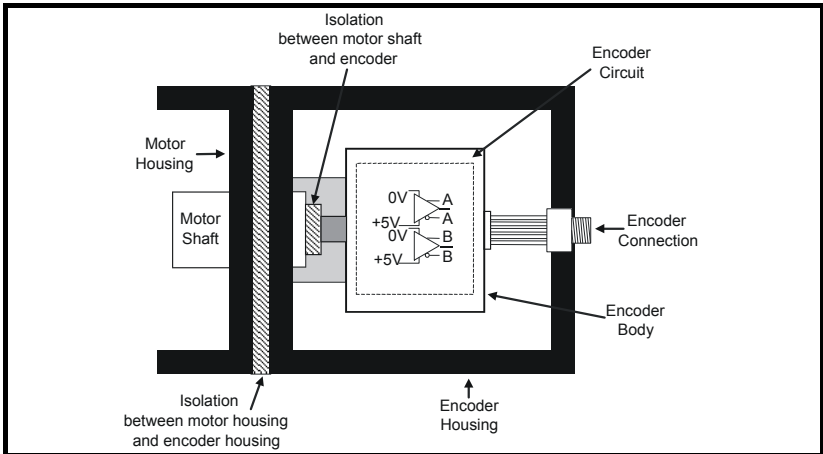

An example of this is the Unimotor, where isolation from the motor is achieved by inserting a plastic mounting plate between the motor housing and encoder housing and a plastic insert fitted in the motor shaft for encoder mounting to the motor shaft. With this preferred method of mounting, noise current is prevented from passing from the motor housing into the encoder housing, and hence into the encoder cable. The ground connection of the cable shield is optional, this may be required to comply with safety measures or to reduce radiated radio frequency emissions from either the drive or encoder.

5.2.2 Encoder circuit with galvanic isolation from encoder body

In this case, the encoder device is mounted directly on the motor housing with contact being made between the motor housing/shaft and encoder. With this mounting method, the encoders internal circuits are exposed to electrical noise from the motor housing through the stray capacitance, and must therefore be designed to withstand this situation. However, this arrangement still prevents large noise currents from flowing from the motor body into the encoder cable.

The ground connection of the cable shield is optional, this may be required to comply with safety measures or to reduce radiated radio frequency emissions from either the drive or encoder.

Figure 5-3 Encoder galvanically isolated from encoder body

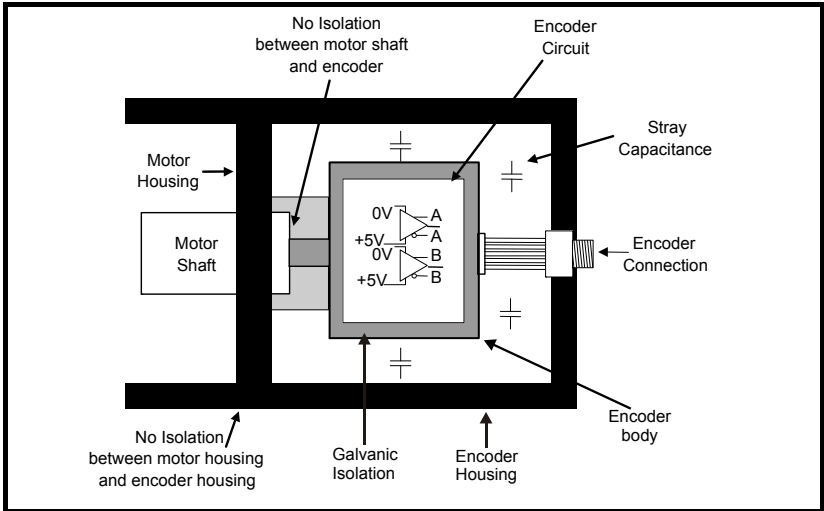

5.2.3 No isolation

As shown in Figure 5-4 the encoder 0 V connection may be permanently connected to the housing. This has the advantage that the encoder body can form a shield for its internal circuits. However it permits noise current from the motor body to flow into the encoder cable shield. A good quality shielded cable correctly terminated protects the data against this noise current, but much more care is needed in ensuring correct cable management than for the isolated cases.

Figure 5-4 No isolation

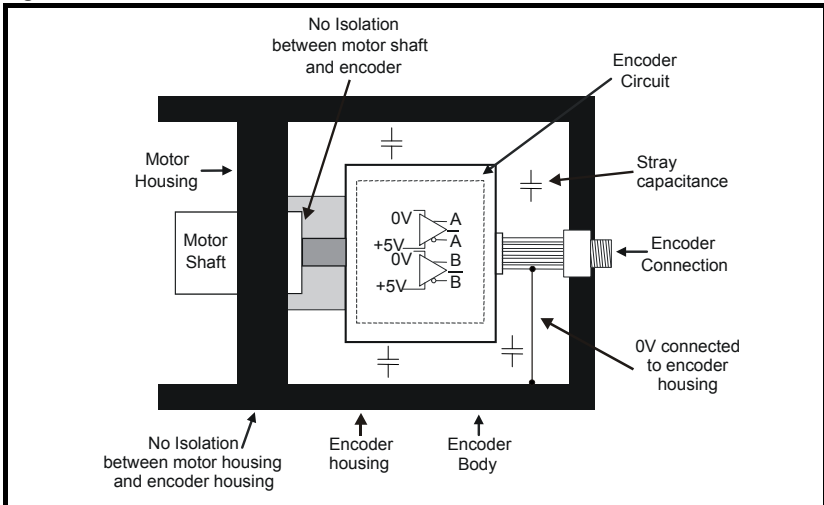

5.2.4 Cable requirements

All mounting methods:

- Shield connection at drive terminal to 0V
- Shield connection at encoder to 0V
- It is recommended that the shielded cable should be run in a continuous length to the terminal, to avoid the injection of noise at intermediate pigtails and to maximise the shielding benefit.
- The shield connections ("pigtails") to the drive and encoder should be kept as short as possible

Mounting with no isolation:

- Shield connected to ground at both ends. The connection must be made by direct fixing of the cable to the grounded metal parts, i.e. to the encoder body and the drive grounding bracket, as illustrated in Figure 4.9. "Pigtails" must be avoided. The outer sheath of the cable should be stripped back enough to allow for the ground clamp to be installed. The shield connection should not be broken. The ground clamps should be located as close as possible to the drive and encoder.
- It is essential that the shielded cable should be run in a continuous length to the terminal, to avoid the injection of noise at intermediate "pigtails" and to maximise the shielding benefit.



In this case under no circumstances must the cable shield connection be omitted at either end of the cable in this case, since the noise voltage may well be sufficient to destroy the line driver and receiver chips in the encoder and the drive.

Cable shield ground connection

For all mounting methods, grounding of the feedback cable shield has added benefits. It can protect the drive and encoder from induced fast electrical transients, and prevent radiated radio-frequency emission. However it is essential that it be carried out in the correct manner as explained above and shown in Figure 5-6.



Connecting the cable shield to ground at both ends carries the risk that an electrical fault might cause excessive power current to flow in the cable shield and overheat the cable. There must be an adequately rated safety ground connection between the motor/encoder and the drive.

Recommended Cable

The recommended cable for feedback signals is a twisted pair, shielded with an overall shield as shown below.

Figure 5-5 Feedback cable, twisted pair

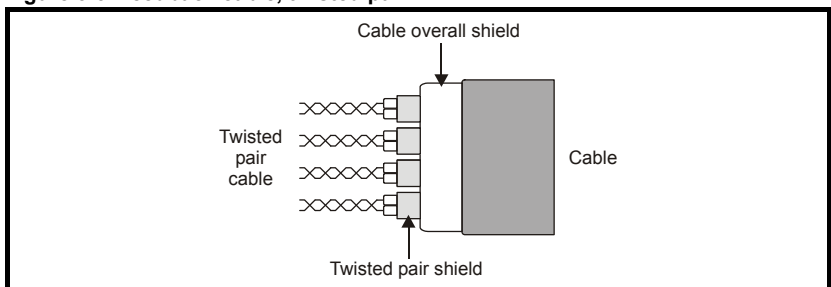

Using this type of cable also allows for the connection of the outer shield to ground and the inner shields to 0 V alone at both drive and encoder end, when required.

NOTE

Ensure that feedback cables are kept as far away as possible from power cables and avoid parallel routing.

Figure 5-6 Feedback cable connections

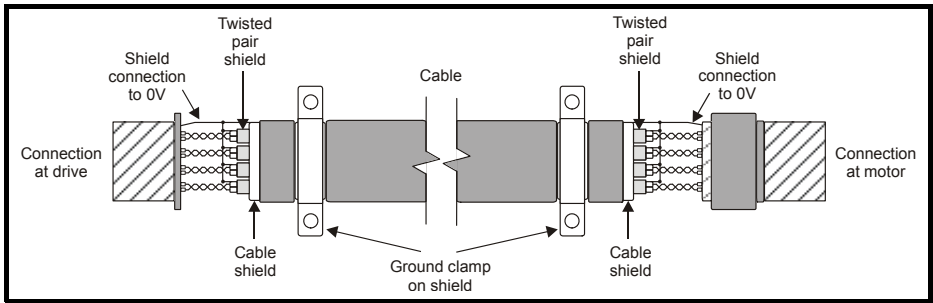

6 Getting started

6.1 Installation



The control circuits are isolated from the power circuits in the drive by basic insulation only, as specified in IEC60664-1. The installer must ensure that the external control circuits are insulated from human contact by at least one layer of insulation rated for use at the AC supply voltage.

If the control circuits are to be connected to other circuits classified as Safety Extra Low Voltage (SELV) (e.g. to a personal computer) an additional isolating barrier must be included in order to maintain the SELV classification.

Encoder connections

In order to ensure correct operation there are a number of checks which should be carried out:

- Ensure the encoder is securely mounted to the motor as spurious operation can result due to the encoder slipping whilst the motor is rotating.
- Ensure encoder connections to both the encoder and the option module terminals are secured, intermittent connections can result in spurious operation or the option module not detecting the feedback signals.
- Ensure shielding recommendations as specified in section 5.2 *Wiring, Shield connections* are followed to prevent noise being induced on the encoder feedback signals. Noise induced on encoder feedback cables cannot only result in spurious operation but in extreme cases can result in encoder failure and/or damage to the option modules encoder input.

Encoder feedback is transmitted from an encoder as low voltage digital signals. Ensure that electrical noise from the drive or motor does not adversely affect the encoder feedback. Ensure that the drive and motor are connected as per the instructions given in the appropriate drive manual, and that the encoder feedback wiring and shielding recommendations are followed in section 5.2 *Wiring, Shield connections* on page 10.

6.2 SI-Encoder set-up

To set-up the SI-Encoder module the following parameter settings should be made.

Action	Detail
Before power-up	Ensure: <ul style="list-style-type: none"> • Drive SAFE TORQUE OFF is not given • Run signal is not given • Option module is installed in appropriate slot • Feedback device is connected
Power up drive	Ensure: <ul style="list-style-type: none"> • Drive displays 'Inhibit' If the drive trips see Chapter 8 Diagnostics on page 29 or refer to the diagnostic section in the <i>Drive User Guide</i> .
Slot identification	Identify which option module slot and menu are being used <ul style="list-style-type: none"> • Slot 1 – Menu 15 • Slot 2 – Menu 16 • Slot 3 – Menu 17
Set-up encoder power supply	Enter: <ul style="list-style-type: none"> • Encoder power supply Pr MM.036 0: 5V, 1: 8V, 2: 15V
Set-up encoder lines per revolution	Enter: <ul style="list-style-type: none"> • Lines per revolution Pr MM.034 Set according to the lines per revolution of the encoder. This must be a power of 2.
Initialization	Ensure: <ul style="list-style-type: none"> • Module Status Pr MM.006 shows "OK" If the SI-Encoder module is configured then the relevant bit in <i>Position Feedback Initialized</i> Pr 03.076 will be set to 1.
Select the option as the source for motor control feedback	If the encoder connected to the SI-Encoder module is to be used for motor control feedback, ensure that Pr 03.026 is set correctly. Valid settings for Pr 03.026 are shown below. <ul style="list-style-type: none"> • Speed feedback selector Pr 03.026 2: P1 Slot1 4: P1 Slot2 6: P1 Slot3

6.3 Termination resistors

By default the termination resistors on the encoder inputs are enabled. The termination resistors can be configured as shown below using encoder termination Pr **MM.039**.

Terminal	Encoder Input	Pr MM.039=0	Pr MM.039=1
1, 2	A, A\	Disabled	Enabled
3, 4	B, B\	Disabled	Enabled

The termination resistance when connected is 120 Ω in total.

7 Parameters

7.1 Menus

The module's menu is displayed in menu 15, 16 or 17 depending on which slot the module is installed in. Table 7.1 below shows the location of the module's menu on the drive.

Table 7.1 Menu location

Slot Number	Menu location
1	15
2	16
3	17

7.2 Single line descriptions

Parameter	Range(⇅)	Default (⇨)	Type						
			RO	Num	ND	NC	PT		
MM.001	Module ID	0 to 65535	105	RO	Num	ND	NC	PT	
MM.002	Software Version	00.00.00.00 to 99.99.99.99		RO	Ver	ND	NC	PT	
MM.003	Hardware Version	00.00 to 99.99		Num	Ver	ND	NC	PT	
MM.004	Serial Number LS	0 to 99999999		RO	Num	ND	NC	PT	
MM.005	Serial Number MS	0 to 99999999		RO	Num	ND	NC	PT	
MM.006	Module Status	Initializing (0), OK (1), Config (2), Error (3)		RO	Txt	ND	NC	PT	
MM.024	Module Temperature	-128 to 127 °C		RO	Num	ND	NC	PT	
MM.025	Slot Indicator	0 to 8		RO	Num	ND	NC	PT	
MM.026	Slot Menu Number	0 to 255		RO	Num	ND	NC	PT	
MM.027	Speed Feedback	-2^{31} to $2^{31}-1$ rpm		RO	Num	ND	NC	PT	
MM.028	Revolution Counter	0 to 65535		RO	Num	ND	NC	PT	
MM.029	Position	0 to 65535		RO	Num	ND	NC	PT	
MM.030	Fine Position	0 to 65535		RO	Num	ND	NC	PT	
MM.033	Turns Bits	0 to 16	16	RW	Num				US
MM.034	Lines Per Revolution	1 to 100000	1024	RW	Num				US
MM.036	Supply Voltage	5 V (0), 8 V (1), 15 V (2)	5 V (0)	RW	Txt				US
MM.039	Termination Select	0 to 1	1	RW	Num				US
MM.040	Error Detection Level	00 to 11	01	RW	Bin				US
MM.042	Feedback Filter	Disabled (0), 1 ms (1), 2 ms (2), 4 ms (3), 8 ms (4), 16 ms (5)	Disabled (0)	RW	Txt				US
MM.043	Maximum Reference	0 to 50000	1500	RW	Num				US
MM.044	Reference Scaling	0.000 to 4.000	1	RW	Num				US
MM.045	Reference	±100.0 %		RO	Num	ND	NC	PT	
MM.046	Reference Destination	0.000 to 59.999	0.000	RW	Num	DE		PT	US
MM.050	Feedback Lock	Off (0) or On (1)	Off (0)	RW	Bit				US
MM.056	Feedback Reverse	Off (0) or On (1)	Off (0)	RW	Bit				US
MM.057	Normalization Turns	0 to 16	16	RW	Num				US
MM.058	Normalized Position	-2^{31} to $2^{31}-1$		RO	Num	ND	NC	PT	
MM.070	Position Feedback Signals	000000 to 111111		RO	Bin	ND	NC	PT	
MM.071	Error Detected	Off (0) or On (1)		RO	Bit	ND	NC	PT	

7.3 Parameter descriptions

MM.001		Module ID	
Minimum	0	Maximum	65535
Default	105	Units	
Type	16 Bit Volatile	Update Rate	Power-up write
Display Format	None	Decimal Places	0
Coding	RO, ND, NC, PT, BU		

Pr **MM.001** displays the ID number for the option module. For the SI-Encoder module this is 105.

MM.002		Firmware version	
Minimum	0 (Display 00.00.00.00)	Maximum	99999999 (Display 99.99.99.99)
Default		Units	
Type	32 Bit Volatile	Update Rate	Power-up write
Display Format	Version Number	Decimal Places	0
Coding	RO, ND, NC, PT		

Pr **MM.002** displays the firmware version of the option module is in the format of **ww.xx.yy.zz**.

MM.003		Hardware version	
Minimum	00.00	Maximum	99.99
Default		Units	
Type	16 Bit Volatile	Update Rate	Power-up write
Display Format	None	Decimal Places	2
Coding	RO, ND, NC, PT		

Pr **MM.003** displays the hardware version of the option module.

How to use this guide
Safety Information
Introduction
Installing the option module
Electrical Installation
Getting started
Parameters
Diagnostics
Terminal data
Index

MM.004	Serial Number LS		
MM.005	Serial Number MS		
Minimum	0	Maximum	99999999
Default		Units	
Type	32 Bit Volatile	Update Rate	Power-up write
Display Format	None	Decimal Places	0
Coding	RO, ND, NC, PT		

The module serial number is available as a pair of 32-bit values where Serial Number LS (Pr **MM.004**) provide the least significant 8 decimal digits, and Serial Number MS (Pr **MM.005**) provides the most significant 8 decimal digits. The reconstructed serial number is ((Pr **MM.005** x 10000000) + Pr **MM.004**). For example serial number "0001234567898765" would be stored as Pr **MM.005** = 123456 and Pr **MM.004** = 67898765.

MM.006	Module Status		
Minimum	0	Maximum	101
Default		Units	
Type	8 Bit Volatile	Update Rate	Background read
Display Format	Text	Decimal Places	0
Coding	RO, TE, ND, NC, PT		

This parameter displays the current status of the module. All possible values are shown in the table below.

Value	Text	Description
0	Initializing	Module is currently initializing.
1	Ok	Module has initialized and has found no errors.
2	Config	A configuration error has been detected in the parameter setting for the module or the module has tripped.
3	Error	An error has occurred preventing the firmware from running correctly.
100	Bootloader	The bootloader is currently running.
101	Updating	The bootloader is currently performing a firmware update. Power must not be turned off in this state.

A configuration error has been detected in the parameter setting for the module or the module has tripped.

MM.024	Module Temperature		
Minimum	-128	Maximum	127
Default	0	Units	°C
Type	8 Bit Volatile	Update Rate	Background write
Display Format	None	Decimal Places	0
Coding	RO, ND, NC, PT		

This parameter displays the current temperature of the module.

MM.025	Slot Indicator		
Minimum	0	Maximum	8
Default		Units	
Type	8 Bit Volatile	Update Rate	Written on power-up
Display Format	None	Decimal Places	0
Coding	RO, ND, NC, PT		

This parameter displays the number of the virtual option slot on the drive that the module is installed in.

MM.026	Slot Menu Number		
Minimum	0	Maximum	255
Default		Units	
Type	8 Bit Volatile	Update Rate	Written on power-up
Display Format	None	Decimal Places	0
Coding	RO, ND, NC, BU		

This parameter displays the menu number of the option slot on the drive.

e.g.

Slot 1 - Menu 15

Slot 2 - Menu 16

Slot 3 - Menu 17

MM.027	Speed Feedback		
Minimum	-2147483648	Maximum	2147483647
Default		Units	rpm
Type	32 Bit Volatile	Update Rate	4 ms write
Display Format	None	Decimal Places	1
Coding	RO, ND, NC, PT		

Provided the set-up parameters for the position feedback device connected to the position interface are correct *Speed Feedback* (Pr **MM.027**) shows the speed derived from the feedback. The speed is given in rpm. The value shown is measured over a 16 ms sliding window period

MM.028	Revolution Counter		
MM.029	Position		
MM.030	Fine Position		
Minimum	0	Maximum	65535
Default		Units	
Type	16 Bit Volatile	Update Rate	4 ms write
Display Format	None	Decimal Places	0
Coding	RO, ND, NC, PT, BU		

Revolution Counter (Pr **MM.028**), *Position* (Pr **MM.029**) and *Fine Position* (Pr **MM.030**) combined give the encoder position with a resolution of $1/2^{32}$ of a revolution as a 48 bit number. These quantities relate directly to the rotary position of the feedback device.

Provided the position feedback interface set-up parameters are correct, the position is always converted to units of $1/2^{32}$ of a revolution, but some parts of the value may not be relevant depending on the resolution of the feedback device

When the position feedback moves by more than one revolution the *Revolution Counter* (Pr **MM.028**) increments or decrements in the form of a sixteen bit roll-over counter.

MM.033	Turns Bits		
Minimum	0	Maximum	16
Default	16	Units	
Type	8 Bit User Save	Update Rate	Background read
Display Format	None	Decimal Places	0
Coding	RW		

It is sometimes desirable to mask off the most significant bits of *Revolution Counter* (Pr **MM.028**), but this does not have to be done for the drive to function correctly. If *Turns Bits* (Pr **MM.033**) = 0 the whole of *Revolution Counter* (Pr **MM.028**) is held at zero. If *Turns Bits* (Pr **MM.033**) has any other value it indicates the number of bits in *Revolution Counter* (Pr **MM.028**) that are not held at zero. For example, if *Turns Bits* (Pr **MM.033**) = 5, then *Revolution Counter* (Pr **MM.028**) counts up to 31 before being reset.

MM.034		Lines Per Revolution	
Minimum	0	Maximum	100000
Default	1024	Units	
Type	32 Bit User Save	Update Rate	Background read
Display Format	None	Decimal Places	0
Coding	RW		

This parameter should be set to the number of lines per revolution for the encoder connected to the position feedback interface.

The value entered must be a power of 2 (e.g. 512, 1024, 2048, 4096, etc). If a value which is a non-power of 2 is entered, the drive will trip with a *Slotx Error.Invalid LPR* trip.

MM.036		Supply Voltage	
Minimum	0	Maximum	2
Default	0	Units	
Type	8 Bit User Save	Update Rate	Background read
Display Format	None	Decimal Places	0
Coding	RW, TE		

Value	Text
0	5 V
1	8 V
2	15 V

Supply Voltage (Pr **MM.036**) sets the level for the supply voltage output. To ensure that the maximum voltage for the position feedback device is not accidentally exceeded, the device should be disconnected from the module when the level is being adjusted.

NOTE

If the output voltage from the encoder is >5 V, then the termination resistors must be disabled Pr **MM.039** to 0.

MM.039		Termination Select	
Minimum	0	Maximum	1
Default	1	Units	
Type	8 Bit User Save	Update Rate	Background read
Display Format	None	Decimal Places	0
Coding	RW		

Termination Select (Pr **MM.039**) is used to enable or disable the terminations on the position feedback interface inputs. The table below shows the functionality of this parameter.

Terminal	Input	Pr MM.039 = 0	Pr MM.039 = 1
1/2 & 3/4	A & B	Disabled	Enabled

NOTE

If the output voltage from the encoder is >5 V, then the termination resistors must be disabled Pr **MM.039** to 0.

MM.040		Error Detection Level	
Minimum	00	Maximum	11
Default	01	Units	
Type	8 Bit User Save	Update Rate	Background read
Display Format	Binary	Decimal Places	0
Coding	RW		

This parameter can be used to enable or disable position feedback trip functions as follows:

Bit	Function
0	Enabled wire break detection
1	Disable module encoder trips

It may be important to detect a break in the connections between the module and the position feedback device. This is accomplished with hardware detectors on the A and B signals that detect a wire break.

This is enabled by setting bit 0 of this parameter to 1.

When setting bit 1 of this parameter, the following trips are disabled:

- PSU Overload
- Config Changed

MM.042		Feedback Filter	
Minimum	0	Maximum	5
Default	0	Units	
Type	8 Bit User Save	Update Rate	Background read
Display Format	None	Decimal Places	0
Coding	RW, TE		

Value	Text
0	Disabled
1	1 ms
2	2 ms
3	4 ms
4	8 ms
5	16 ms

Feedback Filter (Pr **MM.042**) defines the time period for a sliding window filter that may be applied to the feedback taken from the position feedback interface. This is particularly useful in applications where the encoder is used to give speed feedback for the speed controller and where the load includes a high inertia, and so the speed controller gains are very high. Under these conditions, without a filter on the feedback, it is possible for the speed loop output to change constantly from one current limit to the other and lock the integral term of the speed controller.

MM.043		Maximum Reference	
Minimum	0	Maximum	50000
Default	1500	Units	rpm
Type	16 Bit User Save	Update Rate	Background read
Display Format	None	Decimal Places	0
Coding	RW, BU		

MM.044		Reference Scaling	
Minimum	0.000	Maximum	4.000
Default	1.000	Units	
Type	16 Bit User Save	Update Rate	Background read
Display Format	None	Decimal Places	3
Coding	RW		

MM.045		Reference	
Minimum	-100.0	Maximum	100.0
Default		Units	%
Type	16 Bit Volatile	Update Rate	4 ms write
Display Format	None	Decimal Places	1
Coding	RO, FI, ND, NC, PT		

MM.046		Reference Destination	
Minimum	0.000	Maximum	59.999
Default	0.000	Units	
Type	16 Bit User Save	Update Rate	Drive reset read
Display Format	None	Decimal Places	3
Coding	RW, DE, PT, BU		

The speed feedback from the position feedback interface can be used as a source to control a parameter. The speed feedback is scaled to give a value as a percentage of *Maximum Reference* (Pr **MM.043**) in 0.1 % units which is displayed in *Reference* (Pr **MM.045**). The value is then scaled by the *Reference Scaling* (Pr **MM.044**) and then routed to the destination defined by *Reference destination* (Pr **MM.046**). Normally the destination is updated every 4 ms, but if the destination is the *Hard Speed Reference* (Pr **03.022**), *Maximum Reference* (Pr **MM.043**) = VM_SPEED_FREQ_REF[MAX] and *Reference Scaling* (Pr **MM.044**) = 1.000 it is updated every 250 μ s. Although the hard speed reference is updated every 250 μ s internally a value in rpm is written to *Hard Speed Reference* (Pr **03.022**) every 4 ms for indication only.

MM.050		Feedback Lock	
Minimum	0	Maximum	1
Default	0	Units	
Type	1 Bit User Save	Update Rate	Background read
Display Format	None	Decimal Places	0
Coding	RW		

If *Feedback Lock* (Pr **MM.050**) = 1 then *Revolution Counter* (Pr **MM.028**), *Position* (Pr **MM.029**) and *Fine Position* (Pr **MM.030**) are not updated. If *Feedback Lock* (Pr **MM.050**) = 0 then these parameters are updated normally.

MM.056		Feedback Reverse	
Minimum	0	Maximum	1
Default	0	Units	
Type	1 Bit User Save	Update Rate	Background read
Display Format	None	Decimal Places	0
Coding	RW		

If *Feedback Reverse* (Pr **MM.056**) = 1 the position feedback is negated. This can be used to reverse the direction of the position feedback.

MM.057		Normalization Turns	
Minimum	0	Maximum	16
Default	16	Units	
Type	8 Bit User Save	Update Rate	Background read
Display Format	None	Decimal Places	0
Coding	RW		

MM.058		Normalized Position	
Minimum	-2147483648	Maximum	2147483647
Default		Units	
Type	32 Bit Volatile	Update Rate	250 μ s write
Display Format	None	Decimal Places	0
Coding	RO, ND, NC, PT		

The combination of *Revolution Counter* (Pr **MM.028**), *Position* (Pr **MM.029**) and *Fine Position* (Pr **MM.030**) give the position feedback as a 48 bit value. This position cannot be read atomically without locking the position feedback (*Feedback Lock* (Pr **MM.050**) = 1) and it cannot be used directly by the Advanced Motion Controller in the drive. It is useful to be able to create 32 bit position values that can be held by a single parameter as this value can be accessed atomically and can be used directly by the Advanced Motion Controller. *Normalization Turns* (Pr **MM.057**) defines the number of turns bits included in the *Normalized Position* (Pr **MM.058**).

How to use this guide
Safety Information
Introduction
Installing the option module
Electrical Installation
Getting started
Parameters
Diagnostics
Terminal data
Index

MM.070	Position Feedback Signals		
Minimum	0	Maximum	63
Default		Units	
Type	16 Bit Volatile	Update Rate	Background write
Display Format	Binary	Decimal Places	0
Coding	RO, ND, NC, PT		

Position Feedback Signals (Pr **MM.070**) shows the state of the signals from the position feedback device as given in the table below. *Position Feedback Signals* (Pr **MM.070**) is only intended as a debugging aid.

Position Feedback Signals (Pr MM.070) bits	Signals
0	A
1	B
2	Reserved
3	Reserved
4	Reserved
5	Reserved

MM.071	Error Detected		
Minimum	0	Maximum	1
Default		Units	
Type	1 Bit Volatile	Update Rate	Background write
Display Format	None	Decimal Places	0
Coding	RO, ND, NC, PT		

Error Detected (Pr **MM.071**) is set if an error has been detected with the position feedback device connected to the position interface. This parameter is useful if encoder trips have been disabled by setting bit 1 of *Error Detection Level* (Pr **MM.040**). It should be noted that this bit is not set if wire break detection is disabled with bit 0 of *Error Detection Level* (Pr **MM.040**).

How to use this guide	Safety Information	Introduction	Installing the option module	Electrical installation	Getting started	Parameters	Diagnostics	Terminal data	Index
-----------------------	--------------------	--------------	------------------------------	-------------------------	-----------------	-------------------	-------------	---------------	-------

Figure 7-1 SI-Encoder Plus logic diagram

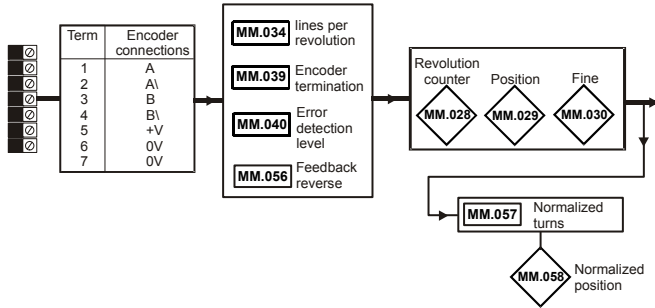

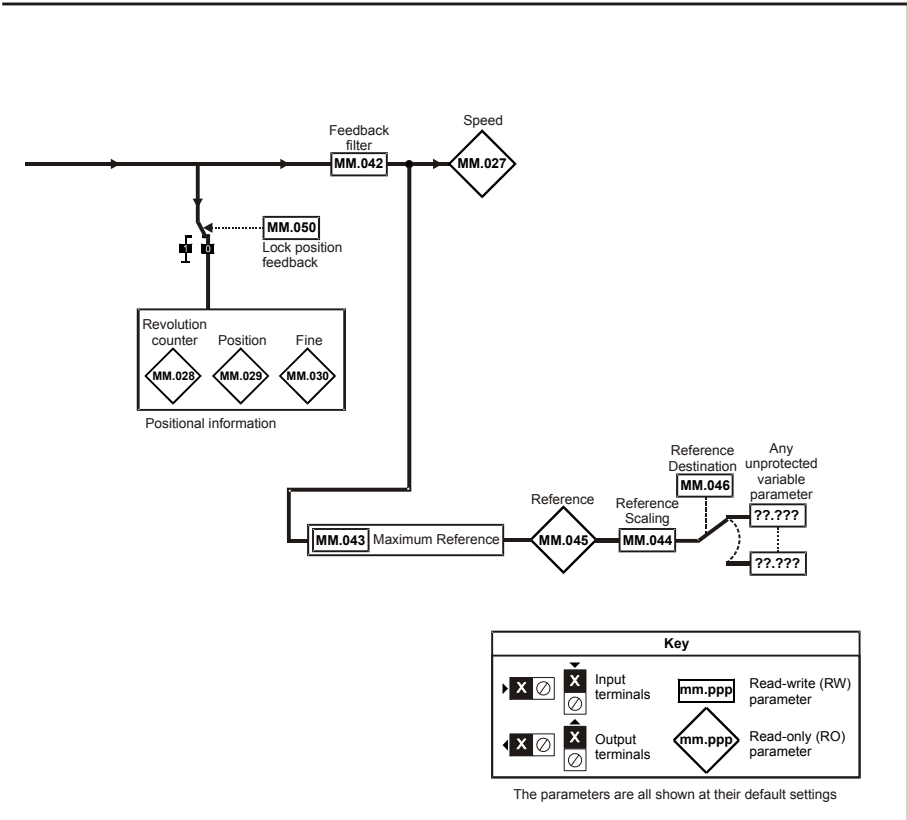

Key			
	Input terminals	mm.ppp	Read-write (RW) parameter
	Output terminals	mm.ppp	Read-only (RO) parameter

The parameters are all shown at their default settings

8 Diagnostics

8.1 Overview

This section provides basic diagnostic information intended to resolve the most common problems encountered when setting up an SI-Encoder option module.

8.1.1 Drive trip display codes

If the option module detects an error during operation, it will force a trip on the drive. The exact reason for the trip will be logged in the drive trip log.

The table below shows the possible trips that will be displayed on the drive when a problem is detected with the option module or when the option module initiates a trip.

Table 8.1 Drive trip display codes

Trip	Description
SlotX HF	The drive has detected that an option module is present but is unable to communicate with it due to a hardware fault.
SlotX Error	User trip generated by the option module
SlotX Not Fitted	This trip will occur if a drive slot was previously configured with an option module but on power up, no option module was detected.
SlotX Different	This trip will occur if a drive slot was previously configured with an option module but on power up, a different option module was detected. Replacing the option module with another one of the same ID number will not initiate this trip. The trip will also occur if an option module is installed to a previously unused slot.

8.1.2 Module error codes

If the option module detects an internal error during operation, it will force a trip on the drive and provide a sub-trip string for a clearer definition of the trip. The table below shows the possible module error codes.

Table 8.2 Module error codes

Value	Text	Description
200	FW Invalid	Invalid firmware for hardware revision
201	Drv unknown	Unknown drive type
202	Drv unsupported	Unsupported drive type
203	Mode unknown	Unknown drive mode
204	Mode unsupported	Unsupported drive mode
205	OHT	Over temperature
206	TO drv	The drive has not responded within the watchdog period
207	eCMP	eCMP communication failure
208	TO eCMP Slot1	eCMP communication to slot 1 timeout
209	TO eCMP Slot2	eCMP communication to slot 2 timeout
210	TO eCMP Slot3	eCMP communication to slot 3 timeout
211	TO eCMP Slot4	eCMP communication to slot 4 timeout
212	Factory Settings	Factory settings file missing
213	No Config	Configuration file missing
214	Self Test	Power on self test failed
215	Read Parameter	Parameter read failed
216	Write Parameter	Parameter write failed
217	Runtime Config	Runtime configuration error
218	File System	File system generic error
219	Config Save	Configuration file save failed

8.1.3 Encoder error codes

If the option module detects an Encoder error during operation, it will force a trip on the drive and provide a sub-trip string for a clearer definition of the trip. Table 8.3 below shows all possible encoder error codes.

Table 8.3 Encoder error codes

Value	Text	Description
100	Wire Break A	Wire break detected on A, A/ input
101	Wire Break B	Wire break detected on B, B/ input
102	PSU Overload	Encoder power supply current is too high
103	Invalid LPR	Invalid lines per revolution. Ensure that a power of 2 is used
104	Internal Error	Internal Error
105	Config Changed	Encoder configuration has changed

How to use this guide
Safety Information
Introduction
Installing the option module
Electrical Installation
Getting started
Parameters
Diagnostics
Terminal data
Index

9 Terminal data

9.1 Encoder inputs

1	Channel A, Frequency or Forward inputs
2	Channel A\, Frequency\ or Forward\ inputs
3	Channel B, Direction or Reverse inputs
4	Channel B\, Direction\ or Reverse\ inputs
Type	EIA 485 differential receivers
Maximum frequency	500 kHz
Line loading	<2 unit loads
Line termination components	120 Ω
Working common mode range	+12 Vdc to -7 Vdc
Absolute maximum applied voltage relative to 0 V	± 25 V
Absolute maximum applied differential voltage	± 25 V

5	Encoder Supply Voltage
Supply voltage	5 V, 8 V or 15 V
Maximum output current	300 mA for 5 V and 8 V 200 mA for 15 V

6, 7	0V Common
-------------	------------------

Index

C	
Cable requirements	13
Cautions	5
Compliance with regulations	6
D	
Diagnostics	32
E	
Electrical noise	15
Electrical safety	5
Encoder circuit with galvanic isolation from encoder body	11
Encoder inputs	34
Encoder simulation output	16
Encoder with galvanic isolation from motor	11
Environmental limits	6
F	
Features	7
Feedback cable	13, 15
Feedback cable connections	14
G	
Galvanic isolation	10
I	
Incremental encoders	8
Installation	15
L	
Line loading	34
M	
Maximum frequency	34
N	
No isolation	12, 13
Notes	5
P	
Parameters - adjusting	6
Power cables	14
S	
Set-up parameters	7
Shield connections	10, 13
Stored charge	6
System design and safety of personnel	5

T	
Terminal data	34
Terminal descriptions	9
Termination resistors	16
W	
Warnings	5
Wiring connections	15



0478-0127-01